

## Sink S4001

Kitchen Sinks

Code: 3356 850



### DETAILS

Edge/Installation Type	Undermount
Finish	Foster brushed
Material	AISI 304 stainless steel
Texture	Brushed in line
Base	45 cm
Dimensions	440x440 mm
Standard fittings	Fixing hooks, gasket, drain, overflow and siphon, boxed packing
Mixer holes	No standard holes
Built-in hole	View technical data sheet

Drainer	No
Width	44 cm
Bowl dimension	400x400mm
Number of bowls	1 bowl
Waste fitting	Drain SPACE 3,5"

## FEATURES

Deep bowls	This bowls reach an important depth, over 20 cm, thanks to the advanced production technology, that can be offer great capiciency and practicity in all the washing operations.
High thickness	1mm thick steel. A significant thickness, which guarantees the maximum sturdiness and durability.
Perimetral overflow	The overflow is always a security on the Foster sinks that prevents the overflow of water in case of oversights. The perimeter drain solution improves aesthetics thanks to its square and essential shape.
Save space system	Drain and siphon are designed to leave as much space as possible in the under-sink area, more and more useful today for theseparate waste collection systems.
Small radius	Bowls with squared shapes with a modern design and an increased capacity, for a minimal aesthetics connected with an extreme practicity.
Space waste fitting	The elegant SPACE steel cap closes the drain and leaves no visible residues collected in the basket below. Space also has a small footprint and allows the optimal use of the under-sink compartment.

## TECHNICAL DATA

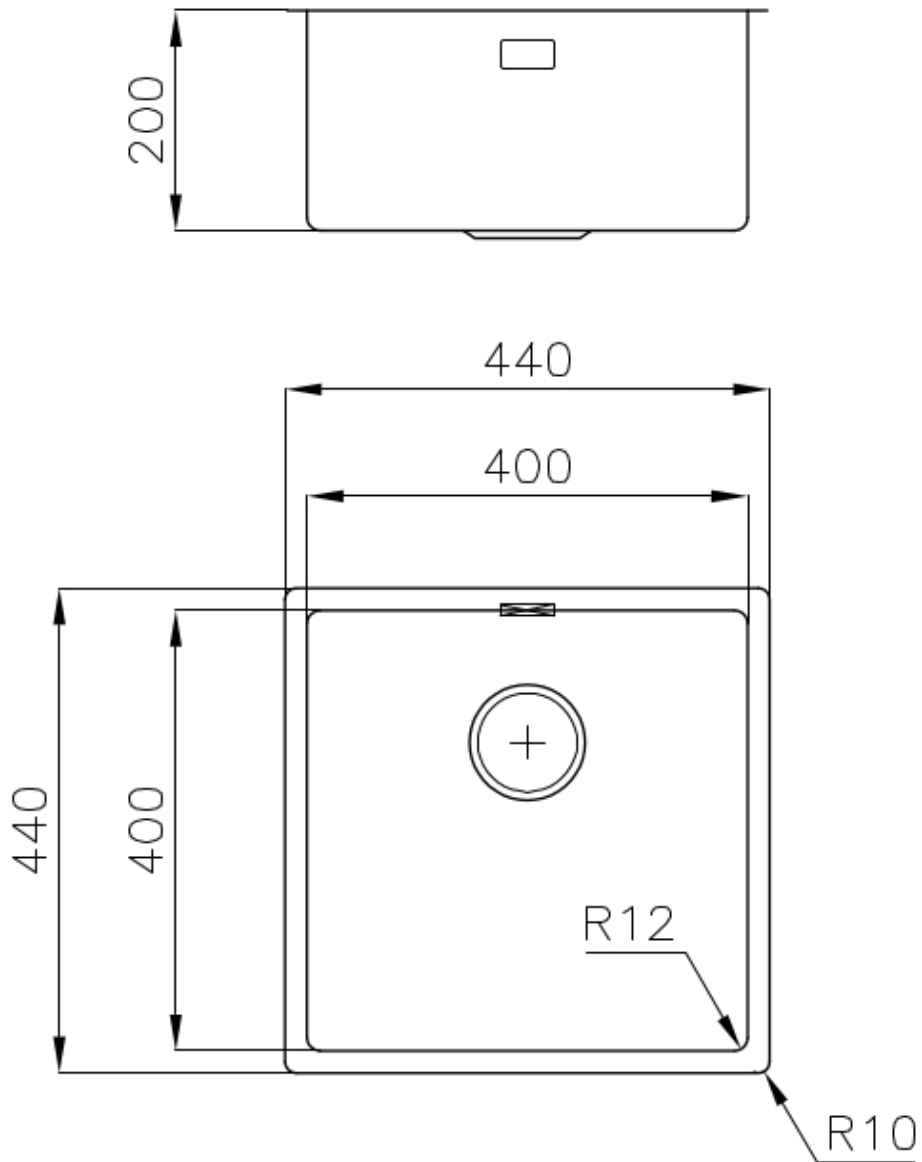

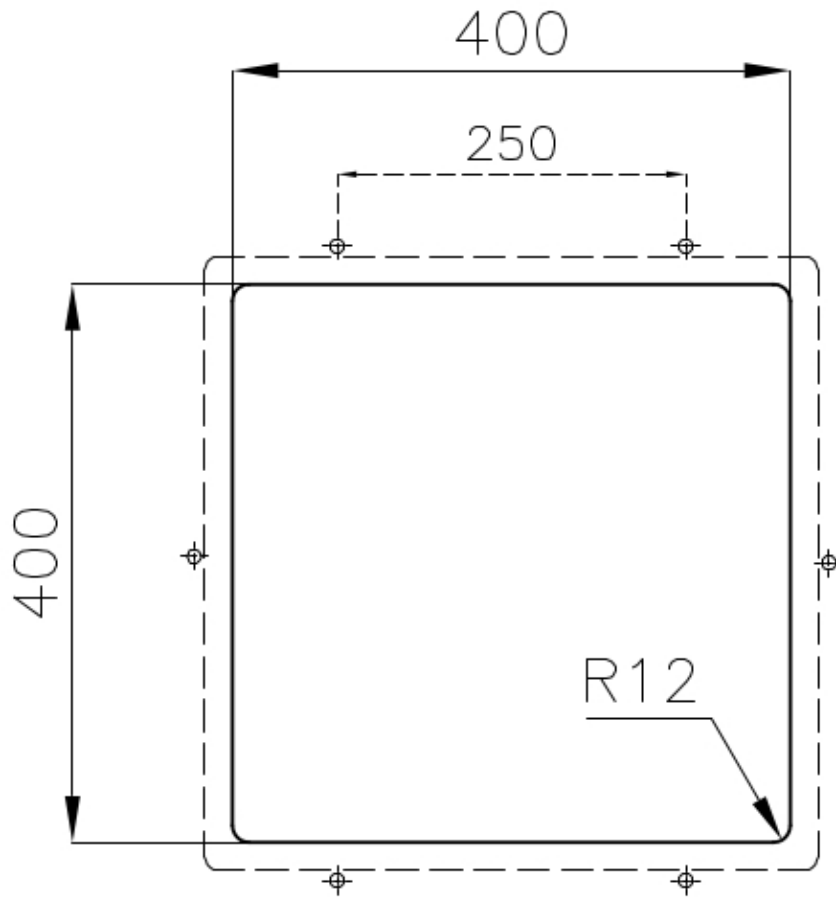

## OPTIONAL ACCESSORIES



**Cestello inox**  
8612 000



**Glass chopping board**  
8631 300



**HPDE Chopping board**  
8657 001



**HPDE Twin chopping board**  
8644 101



**Stainless steel plate rack**  
8100 154

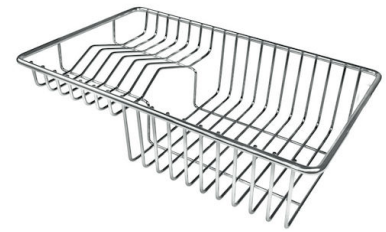

**Stainless steel plate rack**  
8100 303  
\* only in combination with the accessory  
8644 101



**Stainless steel plate rack**  
8100 201



**White bowl**  
8153 100



**Graters kit with ring-holder and  
food collection tray**  
8159 101  
\* only in combination with the accessory  
8644 101



**Stainless steel perforated tray**  
8151 000  
\* only in combination with the accessory  
8644 101

## OPTIONAL AUTOMATIC WASTE FITTINGS



**Automatic waste fitting - PM**  
8407 113



**Space automatic waste fitting - PA**  
8407 108



**Space automatic waste fitting - PE**  
8407 109



**Space Light automatic waste fitting  
- PL**  
8407 117



**Space Milano automatic waste  
fitting**  
8407 115



**Space Push automatic waste fitting  
- PP**  
8407 116